



RAINWATER DRAINAGE SYSTEM

a **LESSO** company

★★★
LEAD-FREE

PIPE SYSTEMS

SUITABLE FOR BUILDINGS,
HOUSES AND CIVIL
CONSTRUCTION PURPOSES.

LESSO





CONTENTS



SYSTEM FEATURES & ADVANTAGES

2 2 Rainwater System

ACCREDITATION & SPECIFICATION

4 4 Quality & Certification

PIPES & FITTINGS DETAILS

5 5 Rainwater Pipes
8 Rainwater Fittings

SPECIFICATIONS

22 22 Specifications

ABOUT US

23 23 About Lesso Malaysia Industries
23 About China Lesso Group

PRODUCT RANGE

RAINWATER SYSTEM

FEATURES

- Dimensions and performance meet the requirement of standards
- High quality of finish with smooth internal external surface
- Provides low coefficient of flow friction
- Formulated to withstand weathering effect
- Available in several stiffness class to accommodate various installations needs

ADVANTAGES

- Chemical Resistance
- Non-Conductivity
- Weather Resistance
- No Rot, Rust or Corrosion
- Tough and Durable
- Low Maintenance

APPLICATION

Lead-free Rainwater Pipe Systems are suitable for buildings, houses and civil construction purposes



- Enhanced stiffness by 40%
- Additional strength
- Resist negative / vacuum conditions
- Withstand intermittent positive pressure

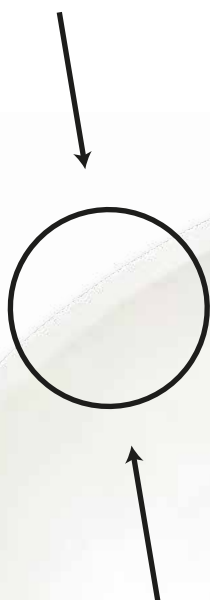
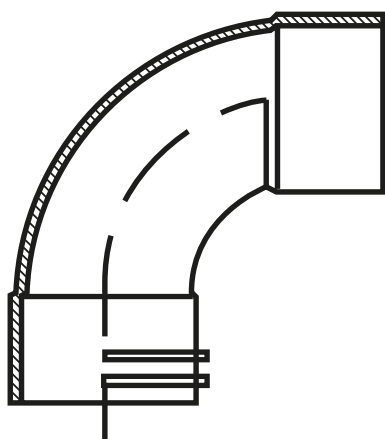

PRODUCT RANGE

HEAVY DUTY BEND

FEATURES

- Higher stiffness to resist deformation
- Enhanced impact resistance
- Smooth bore with low coefficient of friction
- Prevents algae and microbial growth
- Lead-free



ADVANTAGES

- Provides additional strength to counter deformation against load during concrete casting
- Additional impact strength to prevent cracking or failure from objects infiltration to the system, especially in high rise buildings
- Resists negative pressure or vacuum condition acting on fittings during unsteady state operation
- Withstand intermittent positive pressure in the event of hydraulic jump or flooding in the system



APPLICATION

Lowest connection at the bottom of vertical stack of system to the horizontal drainage pipe or sump, which are prone to extreme operating conditions





QUALITY & CERTIFICATION



SYSTEM CERTIFICATION

PIPES

1. Unplasticized Polyvinyl Chloride (PVC-U) Pipes for Rainwater Discharge (Low and High Temperature) within the Building Structure
2. Unplasticized Polyvinyl Chloride (PVC-U) Rainwater Pipes for above ground application
3. Unplasticized Polyvinyl Chloride (PVC-U) Heavy duty Rainwater Pipes for casting and underground application
4. Paling Ecotech Pipes, made from reprocessed material, is lead free and earns high on Green Building Index

FITTINGS

1. Unplasticized Polyvinyl Chloride (PVC-U) Fittings for Rainwater Discharge (Low and High Temperature) within the Building Structure

SOLVENT CEMENT

1. Coloursolve Polyvinyl Chloride (PVC) Solvent Cement

RAINWATER PIPES

Paling Rainwater Piping System has been developed to meet the need of construction industry for a reliable piping system for channelling rainwater from the roof to the drains. The system is suitable for all applications and types of building, including domestic, commercial and industrial.

As the scope of BS EN 12200 Rainwater Goods & Accessories covers rainwater pipes in nominal sizes from 82mm to 160mm only, additional sizes and classes of rainwater pipes have been incorporated in the Paling Rainwater Piping System to meet different requirements of BS EN 1329-1, BS 4514, MS 1063 and BS EN ISO 1452.

The Normal Duty Pipe is intended for exposed installation on the building that do not exceed five storeys in height, such as terrace houses or low-rise shop-houses. The Medium Duty is intended for exposed installation on building exceeding five storeys while the Heavy Duty is designed with higher ring stiffness for use in pipework to be encased in reinforced concrete (RC) columns.

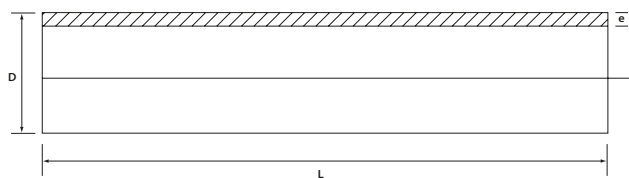

NORMAL DUTY RAINWATER DOWNPIPE (PLAIN END)

- Recommended for expose installation for low rise (5 Storey and Below)

CODE NO.	NOM. SIZE (mm)	SPECIFICATION	PIPE END	MEAN OUTSIDE DIAMETER D (mm)	MIN. WALL THICKNESS e (mm)	LENGTH L (meter)
1220 082 58 ND 01	82	BS EN 12200	PE	82.4 - 82.8	1.8	5.8
1220 110 58 ND 01	110	BS EN 12200	PE	110.0 - 110.3	2.2	5.8
1220 160 58 ND 01	160	BS EN 12200	PE	160.0 - 160.4	3.2	5.8

MEDIUM DUTY RAINWATER DOWNPIPE (PLAIN END)

- Recommended for expose installation (High Rise)

CODE NO.	NOM. SIZE (mm)	SPECIFICATION	PIPE END	MEAN OUTSIDE DIAMETER D (mm)	MIN. WALL THICKNESS e (mm)	LENGTH L (meter)
1220 082 58 MD 01	82	BS 4514 / BS EN 12200	PE	82.4 - 82.8	3.0	5.8
1220 110 58 MD 01	110	BS EN 1329 / BS EN 12200	PE	110.0 - 110.4	3.2	5.8
1220 160 58 MD 01	160	BS EN 1329 / BS EN 12200	PE	160.0 - 160.4	4.0	5.8
1220 200 58 MD 01	200	BS EN 1329 / BS EN 12200	PE	200.0 - 200.5	4.9	5.8
1220 250 58 MD 01	250	BS EN 1329 / BS EN 12200	PE	250.0 - 250.5	6.2	5.8
1220 315 58 MD 01	315	BS EN 1329 / BS EN 12200	PE	315.0 - 315.6	7.7	5.8

MEDIUM HI-DUTY / PN 10 RAINWATER DOWNPIPE (PLAIN END)

- Recommended for low rise casting & extreme expose installation

CODE NO.	NOM. SIZE (mm)	SPECIFICATION	PIPE END	MEAN OUTSIDE DIAMETER D (mm)	MIN. WALL THICKNESS e (mm)	LENGTH L (meter)
1220 110 58 P10 20	110	BS EN ISO 1452 / BS EN 12200 / BS EN 1329	PE	110.0 - 110.3	4.2	5.8
1220 160 58 P10 20	160	BS EN ISO 1452 / BS EN 12200 / BS EN 1329	PE	160.0 - 160.4	6.2	5.8
1220 200 58 P10 20	200	BS EN ISO 1452 / BS EN 12200 / BS EN 1329	PE	200.0 - 200.5	7.7	5.8
1220 250 58 P10 20	250	BS EN ISO 1452 / BS EN 12200 / BS EN 1329	PE	250.0 - 250.5	9.6	5.8
1220 315 58 P10 20	315	BS EN ISO 1452 / BS EN 12200 / BS EN 1329	PE	315.0 - 315.6	12.1	5.8

Medium Hi-Duty : Greyish White

The thickness comply to PN 10 (BS EN ISO 1452)

HEAVY DUTY / PN 12.5 RAINWATER DOWNPIPE (PLAIN END)

CODE NO.	NOM. SIZE (mm)	SPECIFICATION	PIPE END	MEAN OUTSIDE DIAMETER D (mm)	MIN. WALL THICKNESS e (mm)	LENGTH L (meter)
1220 056 58 P12 20	56	BS EN ISO 1452 / BS EN 1329 / BS EN 12200	PE	55.8 - 56.1	3.0	5.8
1220 082 58 P12 20	82	BS EN ISO 1452 / BS EN 12200 / BS 4514	PE	82.4 - 82.8	4.6	5.8
1220 110 58 P12 20	110	BS EN ISO 1452 / BS EN 12200	PE	110.0 - 110.3	5.3	5.8
1220 160 58 P12 20	160	BS EN ISO 1452 / BS EN 12200	PE	160.0 - 160.4	7.7	5.8
1220 200 58 P12 20	200	BS EN ISO 1452 / BS EN 12200	PE	200.0 - 200.5	9.6	5.8
1220 250 58 P12 20	250	BS EN ISO 1452 / BS EN 12200	PE	250.0 - 250.5	11.9	5.8
1220 315 58 P12 20	315	BS EN ISO 1452 / BS EN 12200	PE	315.0 - 315.6	15.0	5.8

Heavy Duty : Greyish White

The thickness comply to PN 12.5 (BS EN ISO 1452)

(ECOTECH PIPE (PLAIN END))

CODE NO.	NOM. SIZE (mm)	SPECIFICATION	PIPE END	OUTSIDE DIAMETER D (mm)	MIN. WALL THICKNESS e (mm)	LENGTH L (meter)	TYPE OF PIPE
1230 082 58 01	82	BS 4514 / BS EN 12200	PE	82.4 - 82.8	3.0	5.8	Medium Duty
1230 110 58 01	110	BS EN 1329 / BS EN 12200	PE	110.0 - 110.3	3.2	5.8	Medium Duty
1230 160 58 01	160	BS EN 1329 / BS EN 12200	PE	160.0 - 160.4	3.2	5.8	Normal Duty
1230 160 58 BD 01	160	BS EN 1329 / BS EN 12200	PE	160.0 - 160.4	4.0	5.8	Medium Duty

NORMAL DUTY RAINWATER DOWNPIPE (SOCKET END)

- Recommended for expose installation for low rise (5 Storey and Below)

CODE NO.	NOM. SIZE (mm)	SPECIFICATION	PIPE END	MEAN OUTSIDE DIAMETER D (mm)	MIN. WALL THICKNESS e (mm)	LENGTH L (meter)
1222 082 58 ND 01	82	BS EN 12200	SE	82.4 - 82.8	1.8	5.8
1222 110 58 ND 01	110	BS EN 12200	SE	110.0 - 110.3	2.2	5.8
1222 160 58 ND 01	160	BS EN 12200	SE	160.0 - 160.4	3.2	5.8

MEDIUM DUTY RAINWATER DOWNPIPE (SOCKET END)

- Recommended for expose installation (High Rise)

CODE NO.	NOM. SIZE (mm)	SPECIFICATION	PIPE END	MEAN OUTSIDE DIAMETER D (mm)	MIN. WALL THICKNESS e (mm)	LENGTH L (meter)
1222 082 58 MD 01	82	BS 4514 / BS EN 12200	SE	82.4 - 82.8	3.0	5.8
1222 110 58 MD 01	110	BS EN 1329 / BS EN 12200	SE	110.0 - 110.4	3.2	5.8
1222 160 58 MD 01	160	BS EN 1329 / BS EN 12200	SE	160.0 - 160.4	4.0	5.8
1222 200 58 MD 01	200	BS EN 1329 / BS EN 12200	SE	200.0 - 200.5	4.9	5.8
1222 250 58 MD 01	250	BS EN 1329 / BS EN 12200	SE	250.0 - 250.5	6.2	5.8
1222 315 58 MD 01	315	BS EN 1329 / BS EN 12200	SE	315.0 - 315.6	7.7	5.8

MEDIUM HI-DUTY / PN 10 RAINWATER DOWNPIPE (SOCKET END)

- Recommended for low rise casting & extreme expose installation

CODE NO.	NOM. SIZE (mm)	SPECIFICATION	PIPE END	MEAN OUTSIDE DIAMETER D (mm)	MIN. WALL THICKNESS e (mm)	LENGTH L (meter)
1222 110 58 P10 20	110	BS EN ISO 1452 / BS EN 12200 / BS EN 1329	SE	110.0 - 110.3	4.2	5.8
1222 160 58 P10 20	160	BS EN ISO 1452 / BS EN 12200 / BS EN 1329	SE	160.0 - 160.4	6.2	5.8
1222 200 58 P10 20	200	BS EN ISO 1452 / BS EN 12200 / BS EN 1329	SE	200.0 - 200.5	7.7	5.8
1222 250 58 P10 20	250	BS EN ISO 1452 / BS EN 12200 / BS EN 1329	SE	250.0 - 250.5	9.6	5.8
1222 315 58 P10 20	315	BS EN ISO 1452 / BS EN 12200 / BS EN 1329	SE	315.0 - 315.6	12.1	5.8

Medium Hi-Duty : Greyish White

The thickness comply to PN 10 (BS EN ISO 1452)

HEAVY DUTY / PN 12.5 RAINWATER DOWNPIPE (SOCKET END)

- Recommended for casting / underground columns

CODE NO.	NOM. SIZE (mm)	SPECIFICATION	PIPE END	MEAN OUTSIDE DIAMETER D (mm)	MIN. WALL THICKNESS e (mm)	LENGTH L (meter)
1222 056 58 P12 20	56	BS EN ISO 1452 / BS EN 1329 / BS EN 12200	SE	55.8 - 56.1	3.0	5.8
1222 082 58 P12 20	82	BS EN ISO 1452 / BS EN 12200 / BS 4514	SE	82.4 - 82.8	4.6	5.8
1222 110 58 P12 20	110	BS EN ISO 1452 / BS EN 12200	SE	110.0 - 110.3	5.3	5.8
1222 160 58 P12 20	160	BS EN ISO 1452 / BS EN 12200	SE	160.0 - 160.4	7.7	5.8
1222 200 58 P12 20	200	BS EN ISO 1452 / BS EN 12200	SE	200.0 - 200.5	9.6	5.8
1222 250 58 P12 20	250	BS EN ISO 1452 / BS EN 12200	SE	250.0 - 250.5	11.9	5.8
1222 315 58 P12 20	315	BS EN ISO 1452 / BS EN 12200	SE	315.0 - 315.6	15.0	5.8

Heavy Duty : Greyish White

The thickness comply to PN 12.5 (BS EN ISO 1452)

ECOTECH PIPE (SOCKET END)

CODE NO.	NOM. SIZE (mm)	SPECIFICATION	PIPE END	OUTSIDE DIAMETER D (mm)	MIN. WALL THICKNESS e (mm)	LENGTH L (meter)	TYPE OF PIPE
1232 082 58 01	82	BS 4514 / BS EN 12200	SE	82.4 - 82.8	3.0	5.8	Medium Duty
1232 110 58 01	110	BS EN 1329 / BS EN 12200	SE	110.0 - 110.3	3.2	5.8	Medium Duty
1232 160 58 01	160	BS EN 1329 / BS EN 12200	SE	160.0 - 160.4	3.2	5.8	Normal Duty
1232 160 58 BD 01	160	BS EN 1329 / BS EN 12200	SE	160.0 - 160.4	4.0	5.8	Medium Duty

All socket ended pipes are for export market only

HEAVY DUTY SWEEP BEND

For solvent weld to pipe at both end
Recommended for casting and lowest connection at the bottom of the stack to horizontal drainage pipe

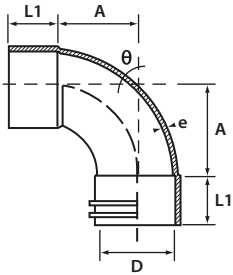

CODE NO.	NOM. SIZE (mm)	ANGLE θ	DIMENSIONS (mm)			MIN W/T e (mm)
			L1	A	D	
2201 110 HD 20	110	87.5°	51	73	110	5
2201 160 HD 20	160	87.5°	76	120	160	7
2201 200 HD 20	200	89°	94	110	200	9

Color : Greyish White

SWEEP BEND

For solvent weld to pipe at both end

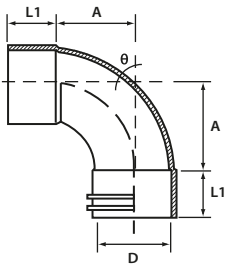

CODE NO.	NOM. SIZE (mm)	ANGLE θ	DIMENSIONS (mm)		
			L1	A	D
2201 036 01	36	87.5°	24	28	36
2201 043 01	43	87.5°	28	27	43
2201 056 01*	56	87.5°	30	40	56
2201 082 01	82	87.5°	45	71	82
2201 110 01*	110	87.5°	51	73	110
2201 160 01*	160	87.5°	76	120	160
2201 200 01*	200	89°	94	118	200
2201 250 01	250	89°	86	144	250
2201 315 01	315	89°	102	185	315

* Available in spigot/spigot and spigot/socket (upon request)

SWEEP BEND (I/O)

with Inspection Opening

To solvent weld to pipe, fitted with inspection opening

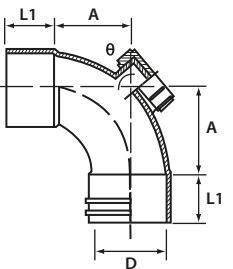

CODE NO.	NOM. SIZE (mm)	ANGLE θ	DIMENSIONS (mm)		
			L1	A	D
2202 043 01	43	87.5°	28	27	43
2202 056 01	56	87.5°	30	40	56
2202 082 01	82	87.5°	45	71	82
2202 110 01*	110	87.5°	51	73	110
2202 160 01*	160	87.5°	76	120	160
2202 200 01*	200	89°	102	137	200
2202 250 01	250	89°	86	144	250
2202 315 01 Δ	315	89°	102	185	315

* Available in spigot/spigot and spigot/socket (upon request)

Δ Fabrication item

68° BEND

To solvent weld to pipe

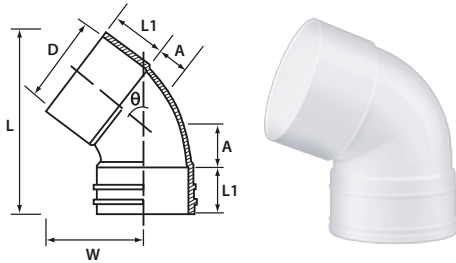

CODE NO.	NOM. SIZE (mm)	ANGLE θ	DIMENSIONS (mm)				
			L	L1	W	A	D
2205 110 01	110	68°	205	52	117	56	110
2205 160 01	160	68°	290	80	170	74	160
2205 200 01*	200	68°	370	100	126	96	200
2205 250 01 Δ	250	68°	-	70	-	100	250
2205 315 01 Δ	315	68°	-	220	-	81	315

* Available in spigot/spigot and spigot/socket (upon request)

Δ Fabrication item

45° BEND

To solvent weld to pipe

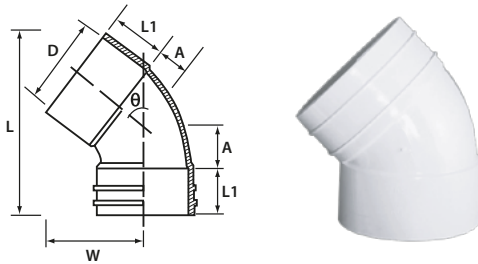

CODE NO.	NOM. SIZE (mm)	ANGLE θ	DIMENSIONS (mm)				
			L	L1	W	A	D
2210 036 01	36	45°	72	23	37	6	36
2210 043 01	43	45°	84	27	45	8	43
2210 056 01	56	45°	96	30	53	10	56
2210 082 01	82	45°	140	43	74	15	82
2210 110 01	110	45°	170	50	93	20	110
2210 160 01	160	45°	255	76	140	30	160
2210 200 01	200	45°	313	88	185	48	200
2210 250 01*	250	45°	380	85	230	75	250
2210 315 01*	315	45°	465	102	263	95	315

* Available in spigot/spigot and spigot/socket (upon request)

45° BEND (I/O)

with Inspection Opening

To solvent weld to pipe, fitted with inspection opening

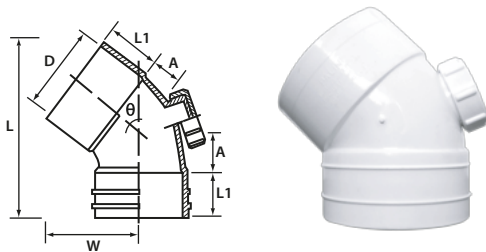

CODE NO.	NOM. SIZE (mm)	ANGLE θ	DIMENSIONS (mm)				
			L	L1	W	A	D
2203 056 01	56	45°	96	30	53	10	56
2203 082 01	82	45°	140	43	74	15	82
2203 110 01	110	45°	170	50	93	20	110
2203 160 01	160	45°	255	76	140	30	160
2203 200 01	200	45°	302	102	185	70	200

SWEEP BRANCH

To solvent weld to pipe, with integrally moulded socket to accept drainage pipe or boss adaptor for inspection opening

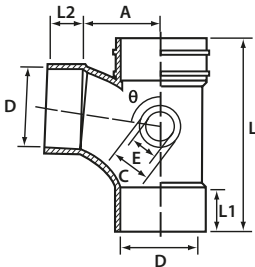

CODE NO.	NOM. SIZE (mm)	ANGLE θ	DIMENSIONS (mm)							
			L	L1	L2	A	C	E	D	D1
2211 036 01	36	87.5°	93	23	23	30	-	-	36	36
2211 043 01	43	87.5°	109	27	27	31	-	-	43	43
2211 056 01	56	87.5°	136	30	30	45	-	-	56	56
2211 056043 01	56 X 43	87.5°	122	31	27	35	-	-	56	43
2211 082 01	82	87.5°	206	45	45	76	-	43	82	82
2211 082056 01	82 X 56	87.5°	190	46	31	60	-	#	82	56
2211 110 01*	110	87.5°	250	50	50	75	-	56	110	110
2211 110056 01	110x56	87.5°	207	51	31	75	-	56	110	56
2211 110082 01	110x82	87.5°	220	51	45	75	-	56	110	82
2211 160 01	160	87.5°	360	77	77	145	82	56	160	160
2211 160110 01	160x110	87.5°	312	76	48	120	-	56	160	110
2211 200 01	200	89°	385	75	75	140	-	-	200	200
2211 200110 01	200x110	88°	294	60	48	110	-	#	200	110
2211 200160 01	200x160	87.5°	400	90	71	148	-	-	200	160
2211 250 01	250	89°	454	82	82	175	-	-	250	250
2211 250160 01	250x160	89°	350	79	57	136	-	-	250	160
2211 250200 01	250x200	89°	454	90	90	180	-	-	250	200
2211 315 01	315	89°	548	90	90	180	-	-	315	315
2211 315200 01	315x200	89°	417	91	69	175	-	-	315	200
2211 315250 01	315x250	89°	470	90	80	181	-	-	315	250

* Available in spigot/spigot and spigot/socket (upon request)

With boss adaptor

SWEEP BRANCH (I/O)

with Inspection Opening

To solvent weld to pipe, with integrally moulded socket to accept drainage pipe
Fitted with inspection opening

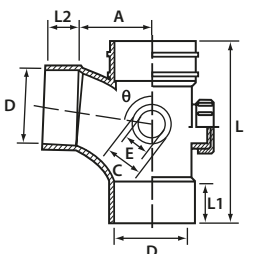

CODE NO.	NOM. SIZE (mm)	ANGLE θ	DIMENSIONS (mm)							
			L	L1	L2	A	C	E	D	D1
2212 043 01	43	87.5°	109	27	27	31	-	-	43	43
2212 056 01	56	87.5°	136	30	30	45	-	-	56	56
2212 082 01	82	87.5°	206	45	45	76	-	43	82	82
2212 110 01*	110	87.5°	250	50	50	75	-	56	110	110
2212 160 01	160	87.5°	360	77	77	145	82	56	160	160
2212 160110 01	160x110	87.5°	312	76	48	120	-	56	160	110
2212 200 01	200	89°	403	102	102	150	-	#	200	200
2212 200160 01	200x160	89°	337	75	65	150	-	-	200	160
2212 250 01	250	89°	454	82	82	175	-	-	250	250
2212 250200 01Δ	250x200	89°	454	90	90	180	-	-	250	200
2212 315 01Δ	315	89°	548	90	90	180	-	-	315	315
2212 315250 01Δ	315x250	89°	470	90	80	181	-	-	315	250

* Available in spigot/spigot and spigot/socket (upon request)

Δ Fabrication item

With boss connector

SWEEP BRANCH Left and Right (I/O)

with Inspection Opening (L/R)

To solvent weld to pipe, fitted with inspection opening from left / right

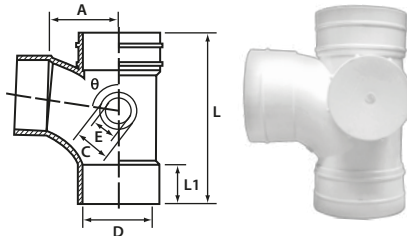

CODE NO.	NOM. SIZE (mm)	ANGLE θ	DIMENSIONS (mm)					
			L	L1	A	C	E	D
2212 110 LE 01•	110	87.5°	250	52	80	56	76	110
2212 110 RI 01#	110	87.5°	250	52	80	56	76	110

- Branch with left opening
- # Branch with right opening

45° Y BRANCH

To solvent weld to pipe, with integrally moulded socket to accept drainage pipe or boss adaptor for inspection opening

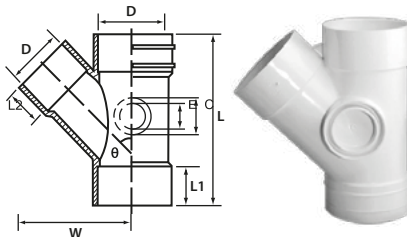

CODE NO.	NOM. SIZE (mm)	ANGLE θ	DIMENSIONS (mm)							
			L	L1	L2	W	C	E	D	D1
2213 056 01	56	45°	152	30	30	96	-	-	56	56
2213 082 01	82	45°	205	44	44	136	-	43	82	82
2213 110 01	110	45°	266	51	51	175	75	56	110	110
2213 110056 01	110x56	45°	226	52	31	120	-	#	110	56
2213 110082 01	110x82	45°	257	52	45	150	-	#	110	82
2213 160 01	160	45°	405	75	75	251	-	#	160	160
2213 160110 01	160x110	45°	317	77	50	200	82	56	160	110
2213 200 01	200	45°	451	71	71	300	-	-	200	200
2213 200160 01	200x160	45°	410	70	58	265	-	-	200	160
2213 250 01	250	45°	573	84	84	385	-	-	250	250
2213 250160 01	250x160	45°	410	84	63	-	-	-	250	160
2213 250200 01	250x200	45°	463	85	73	-	-	-	250	200
2213 315 01Δ	315	45°	1035	200	200	610	-	-	315	315

- Δ Fabrication item
- # With boss adaptor

45° Y BRANCH (I/O)

with Inspection Opening

To solvent weld to pipe, with integrally moulded socket to accept drainage pipe Fitted with inspection opening

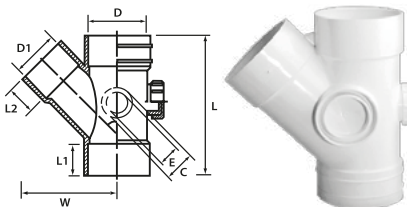

CODE NO.	NOM. SIZE (mm)	ANGLE θ	DIMENSIONS (mm)							
			L	L1	L2	W	C	E	D	D1
2214 056 01	56	45°	152	30	30	96	-	-	56	56
2214 082 01	82	45°	205	44	44	136	-	43	82	82
2214 110 01	110	45°	266	51	51	175	75	56	110	110
2214 110082 01*	110x82	45°	266	51	45	175	75	56	110	82
2214 160110 01	160x110	45°	317	77	50	200	82	56	160	110

- * Combination item comprising Branch (2213 110) and Bush Socket Reducer (2236 110 082)

SWEEP DOUBLE BRANCH

To solvent weld to pipe, with integrally moulded socket to accept drainage pipe or boss adaptor for inspection opening

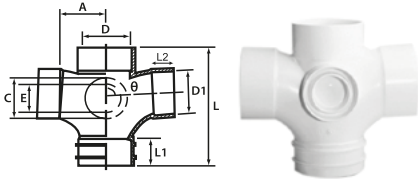

CODE NO.	NOM. SIZE (mm)	ANGLE θ	DIMENSIONS (mm)								
			L	L1	L2	A	C	E	D	D1	
2216 056 01	56	87.5°	136	28	28	48	-	43	56	56	
2216 082 01	82	87.5°	204	45	45	65	-	#	82	82	
2216 110 01	110	87.5°	246	50	50	80	82	56	110	110	
2216 110056 01	110x56	87.5°	207	52	32	78	-	#	110	56	
2216 110082 01	110x82	87.5°	220	52	45	78	-	#	110	82	
2216 160 01	160	89°	320	60	60	105	-	-	160	160	
2216 200 01	200	89°	385	70	70	135	-	-	200	200	
2216 200 110 01	200x110	89°	282	68	48	115	-	-	200	110	
2216 200 160 01	200x160	89°	325	68	58	110	-	-	200	160	
2216 250110 01	250x110	89°	282	68	48	124	-	-	250	110	
2216 250160 01	250x160	89°	300	68	58	122	-	-	250	160	

With boss adaptor

SWEEP DOUBLE BRANCH (I/O)

with Inspection Opening

Socket Plug connected to integrally moulded socket to provide inspection opening

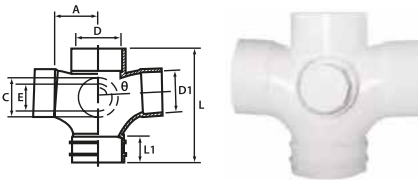

CODE NO.	NOM. SIZE (mm)	ANGLE θ	DIMENSIONS (mm)								
			L	L1	A	C	E	D	D1		
2217 056 01	56	87.5°	136	30	48	-	43	56	56		
2217 110 01	110	87.5°	246	50	80	82	56	110	110		

SWEEP REDUCING DOUBLE BRANCH

To solvent weld to pipe, with integrally moulded socket to accept drainage pipe or socket plug for inspection opening

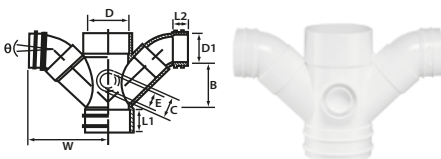

CODE NO.	NOM. SIZE (mm)	ANGLE θ	DIMENSIONS (mm)								
			L1	L2	W	B	C	E	D	D1	
2216 160110 01	160x110	87.5°	77	50	254	115	82	56	160	110	

Combination of 2218 160 110 and 41° Bend

SWEEP REDUCING DOUBLE BRANCH (I/O)

with Inspection Opening

Socket Plug connected to integrally moulded socket to provide inspection opening

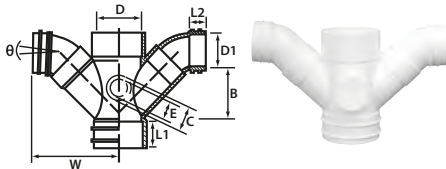

CODE NO.	NOM. SIZE	ANGLE		DIMENSIONS (mm)							
	(mm)	θ	L1	L2	W	B	C	E	D	D1	
2217 160110 01	160x110	87.5°	77	50	254	115	82	56	160	110	

Combination item comprising Reducing Double Branch and 41° Bend

45° REDUCING DOUBLE BRANCH

with integrally moulded socket to accept drainage pipe

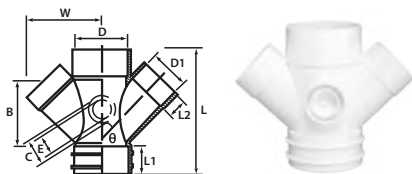

CODE NO.	NOM. SIZE	ANGLE			DIMENSIONS (mm)							
	(mm)	θ	L	L1	L2	W	B	C	E	D	D1	
2218 160110 01	160x110	45°	320	71	50	195	153	82	56	160	110	

45° REDUCING DOUBLE BRANCH (I/O)

with Inspection Opening

To solvent weld to pipe, with integrally moulded socket to accept drainage pipe. Fitted with socket plug for inspection opening

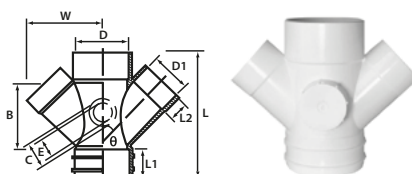

CODE NO.	NOM. SIZE	ANGLE			DIMENSIONS (mm)							
	(mm)	θ	L	L1	L2	W	B	C	E	D	D1	
2219 160110 01	160x110	45°	320	71	50	195	153	82	56	160	110	

TEST OPENING

Allow access opening at any straight location with solvent weld together two lengths of soil or waste pipes

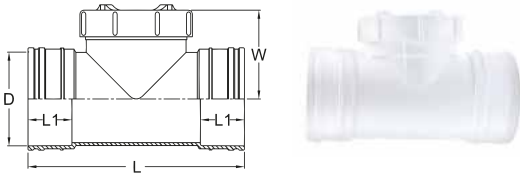

CODE NO.	NOM. SIZE (mm)	DIMENSIONS (mm)			
		L	L1	W	D
TO82	82	212	46	83	82
TO110	110	256	52	105	110
TO160	160	312	77	132	160
TO200	200	380	102	150	200
TO82MF	82	212	46	83	82
TO110MF	110	256	52	105	110
TO160MF 01	160	312	77	132	160

SNOW product

STRAIGHT COUPLER

To solvent weld together two lengths of soil or waste pipes

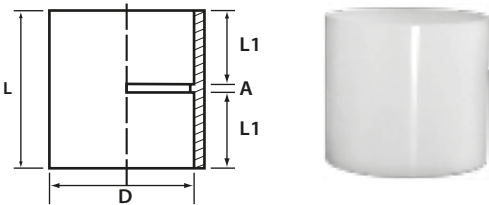

CODE NO.	NOM. SIZE (mm)	DIMENSIONS (mm)			
		L	L1	A	D
2225 036 01	36	50	24	2	36
2225 043 01	43	59	28	3	43
2225 056 01	56	66	32	2	56
2225 082 01	82	97	47	3	82
2225 110 01	110	110	53	4	110
2225 160 01	160	167	82	4	160
2225 200 01	200	184	90	4	200
2225 250 01	250	225	110	5	250
2225 315 01	315	206	100	5	315

EXPANSION COUPLER

To provide expansion joint for pipe connection or other material pipe connection

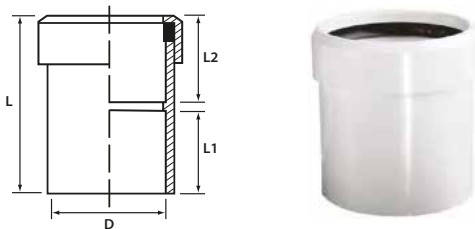

CODE NO.	NOM. SIZE (mm)	DIMENSIONS (mm)			
		L	L1	L2	D
2226 082 01	82	113	47	63	82
2226 110 01	110	133	53	75	110
2226 160 01	160	190	82	104	160

Upon request

PIPE SLEEVE

For cast into RC floor slab / concrete wall to provide a through socket for pipes

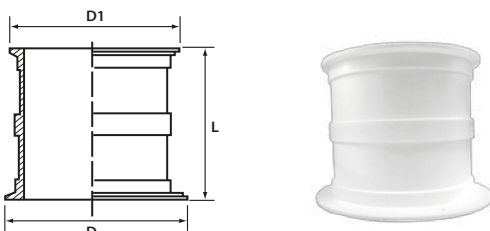

CODE NO.	NOM. SIZE (mm)	DIMENSIONS (mm)		
		L	D	D1
2252 036 01	36	112	72	56
2252 043 01	43	112	79	68
2252 056 01	56	112	92	76
2252 082 01	82	112	120	104
2252 110 01	110	112	147	131
2252 160 01	160	163	199	184

FABRICATED PIPE SLEEVE

For cast into RC floor slab / concrete wall for socket connection with pipes from top and bottom

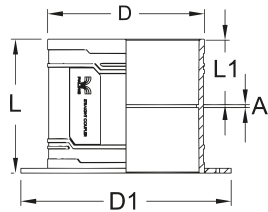

CODE NO.	NOM. SIZE (mm)	DIMENSIONS (mm)				
		L	L1	A	D	D1
2252 200 01Δ	200	184	90	4	200	289
2252 250 01Δ	250	225	110	5	250	342
2252 315 01Δ	315	206	100	5	315	406

Δ Fabrication item

SOCKET PLUG

with Screw on Cap

To plug the socket open-end of a pipeline to allow for later accessibility

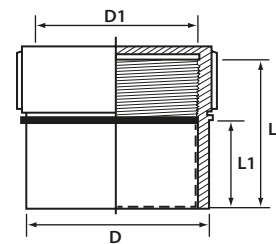

CODE NO.	NOM. SIZE (mm)	DIMENSIONS (mm)			
		L	L1	D	D1
2229 036 01	36	45	23	36	32
2229 043 01	43	50	26	43	43
2229 056 01	56	46	28	56	52
2229 082046 01	82	46	23	82	76
2229 082067 01	82	67	44	82	76
2229 160 01	160	120	102	160	145

use for side opening of 82 mm, not as plug for normal socket

ACCESS CAP AND PLUG (M/F)

To plug the socket open-end of a pipeline to allow for later accessibility as well as future connection by removing the cap

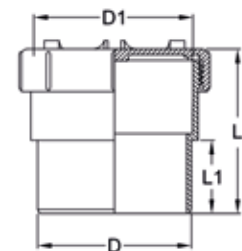

CODE NO.	NOM. SIZE (mm)	DIMENSIONS (mm)		
		L	L1	D/D1
AC100MF	110	114	52	110
AC150MF	160	173	77	160

D is Spigot, D1 is Socket
SNOW product

END CAP WITH ACCESS OPENING

As an end cap to plug the open-end of a pipeline to allow for later

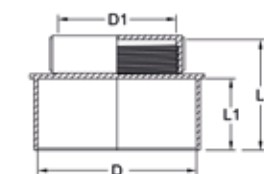

CODE NO.	NOM. SIZE (mm)	DIMENSIONS (mm)			
		L	L1	D	D1
2229 110082 01	110	86	50	110	76
2229 200 01	200	113	68	200	160
2229 250 01	250	152	79	250	200
2229 315 01	315	165	90	315	200

CONCENTRIC REDUCER

To allow for change in pipe diameter with both end socket connect directly with pipe

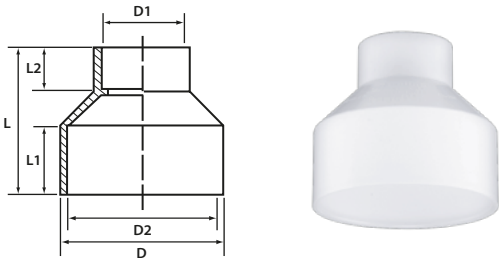

CODE NO.	NOM. SIZE (mm)	DIMENSIONS (mm)					
		L	L1	L2	D	D1	D2
2239 110056 01	110x56	109	50	28	-	56	110
2239 160110 01 #	160x110	145	75	49	160	110	-

D for 160mm is spigot

LEVEL INVERT REDUCER (M/F)

To allow for change in pipe diameter with larger spigot end into socket for fitting or socketed pipe

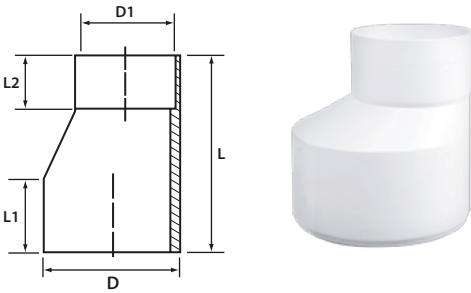

CODE NO.	NOM. SIZE (mm)	DIMENSIONS (mm)				
		L	L1	L2	D	D1
2244 056036 01	56x36	73	25	28	56	36
2244 082056 01	82x56	105	45	27	82	56
2244 110056 01	110x56	150	56	31	110	56
2244 110082 01	110x82	126	50	43	110	82

D is spigot

LEVEL INVERT REDUCER (F/F)

To allow for change in pipe diameter with both end socket connect directly with pipes



CODE NO.	NOM. SIZE (mm)	DIMENSIONS (mm)				
		L	L1	L2	D	D1
2244 200110 01	200x110	192	70	50	200	110
2244 200160 01	200x160	250	100	76	200	160
2244 250110 01	250x110	194	60	48	250	110
2244 250160 01	250x160	222	85	58	250	160
2244 250200 01	250x200	210	85	70	250	200
2244 315200 01	315x200	265	99	70	315	200
2244 315250 01	315x250	255	103	83	315	250

D and D1 are both socket

BUSH / SOCKET REDUCER

To allow for change in fittings socket diameter

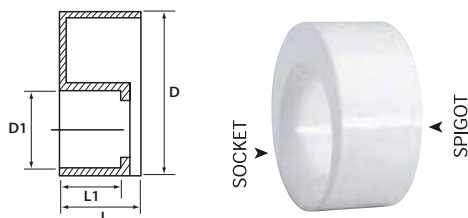

CODE NO.	NOM. SIZE (mm)	DIMENSIONS (mm)			
		L	L1	D	D1
2236 043036 01	43x36	22	19	43	36
2236 056036 01	56x36	28	18	56	36
2236 056043 01	56x43	28	21	56	43
2236 082056 01	82x56	38	28	82	56
2236 110056 01	110x56	50	27	110	56
2236 110082 01	110x82	50	37	110	82
2236 160110 01	160x110	71	48	160	110
2236 200160 01	200x160	90	71	200	160
2236 250110 01	250x110	78	48	250	110
2236 250160 01	250x160	78	59	250	160
2236 315110 01	315x110	90	48	315	110
2236 315160 01	315x160	90	59	315	160
2236 315200 01	315x200	90	75	315	200
2236 315250 01	315x250	90	80	315	250

BOSS CONNECTOR WITH BRACKET

To allow additional inlet / branch by boring the pipe, connect with solvent cement
Incorporate a bracket specially designed to hold the boss connector in place during installation

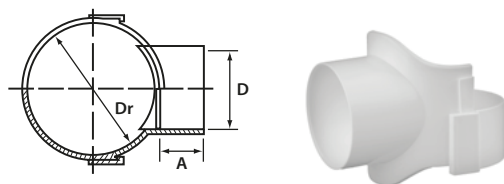

CODE NO.	NOM. SIZE (mm)	DIMENSIONS (mm)		
		Dr	D	A
2243 082036 01	82x36*	82	36	19
2243 082043 01	82x43*	82	43	26
2243 082056 01	82x56	82	56	31
2243 110082 01	110x82	110	82	45

* Combination of Boss Connector & Bush Socket Reducer

BOSS CONNECTOR WITH BRACKET

To allow additional inlet / branch by boring the pipe, connect with solvent cement
Incorporate a bracket specially designed to hold the boss connector in place during installation

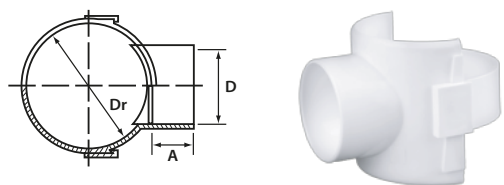

CODE NO.	NOM. SIZE (mm)	DIMENSIONS (mm)		
		Dr	D	A
2243 110036 01	110x36*	110	36	19
2243 110043 01	110x43*	110	43	22
2243 110056 01	110x56	110	56	30
2243 160082 01	160x82	160	82	45

* Combination of Boss Connector & Bush Socket Reducer

INSPECTION OPENING & FRAME

Allow inspection opening at the pipeline

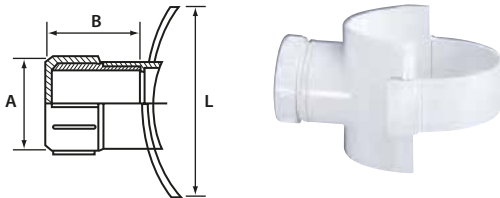

CODE NO.	NOM. SIZE (mm)	DIMENSIONS (mm)		
		L	A	B
2238 082056 01	82x56	92	52	47
2238 110056 01	110x56	122	52	47
2238 110082 01	110x82	122	76	67
2238 160082 01	160x82	175	76	71

TOP REMOVABLE TRAPPED FLOOR GULLY

Top cleaning access with integrally moulded socket 56 mm to accept drainage pipes

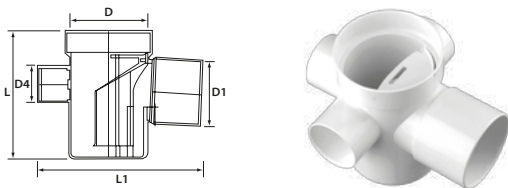

CODE NO.	NOM. SIZE (mm)	DIMENSIONS (mm)				
		L	L1	D	D1	D2-D3-D4
2260 110 01	110x82	174	220	110	82	56

FLOOR GULLY WITH TRAP

with Trap & Inspection Opening

Bottom cleaning access with integrally moulded socket 56 mm to accept drainage pipes and air-con pipe

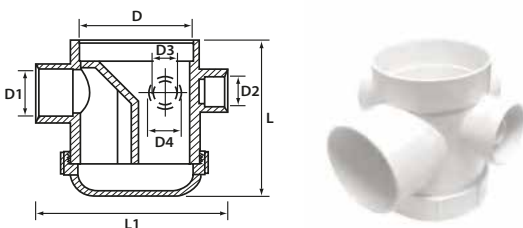

CODE NO.	NOM. SIZE (mm)	DIMENSIONS (mm)					
		L	L1	D	D1	D2-D4	D3
2259 110082 01	110x82	170	200	110	82	56	15

1 and **3** are equipped with 15 mm inlet to accept air-con pipe

PUSH ON CAP

End cap to plug the open end of a pipeline

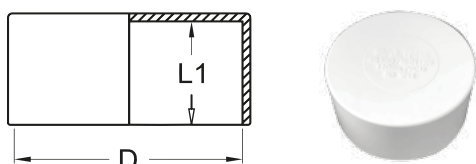

CODE NO.	NOM. SIZE (mm)	DIMENSIONS (mm)	
		L1	D
2230 POC56 01	56	30	56
2230 POC82 01	82	45	82
2230 POC110 01	110	52	110
2230 POC160 01	160	77	160

SNOW product

BALCONY OUTLET GRATING

Suitable for Normal & Medium duty pipe through grating
 2 in 1 - receive rainwater from the top connection and balcony

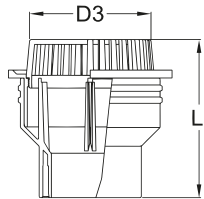

CODE NO.	NOM. SIZE (mm)	DIMENSIONS (mm)	
		D3	L
B03SB213	82	119	199
B04SB213	110	148	205
B06SB213	160	198	237

SNOW product

HEAVY DUTY DOME GRATING

To cap open end of rainwater stack at flat roof

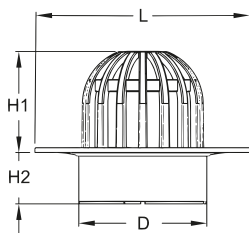

CODE NO.	NOM. SIZE (mm)	DIMENSIONS (mm)			
		L	H1	H2	D
2264 110 HD 01	110	210	110	64	110
2264 160 HD 01	160	270	130	88	160
2264 200 HD 01	200	305	130	90	200
2264 250 HD 01Δ	250	300	130	90	250
2264 315 HD 01Δ	315	350	130	90	315

Δ Fabrication item
 D is spigot

GRATING

Can be seated into 82 mm or 110 mm drainage pipes for floor wells

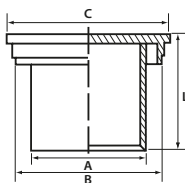

CODE NO.	NOM. SIZE (mm)	DIMENSIONS (mm)	
		L	C
2254 110082 01	110x82	73	110
A - 75 mm	Seats inside 82 mm pipe bore		
B - 110 mm	Seats on 110 mm short length pipe solvent welded to Floor Gully		

EXTENTION GRATING COLLAR

To be used as a collar for grating

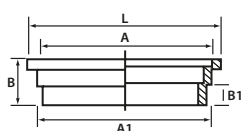

CODE NO.	NOM. SIZE (mm)	DIMENSIONS (mm)				
		L	A	A1	B	B1
2255 110 01	110x14	118	110	110	33	14

FLOOR GULLY WITH TRAP

Floor Gully comes complete with water trap, extension grating collar and grating together with span-in-cover, outlet may be rodded by removing grating

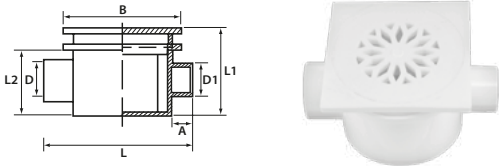

CODE NO.	NOM. SIZE (mm)	DIMENSIONS (mm)						
		L	L1	L2	A	B	D	D1
2258 110046 01	110x43	162	85	71	32	118	43	38

SQUARE FLAT GRATING

with Edge, with or without Spigot

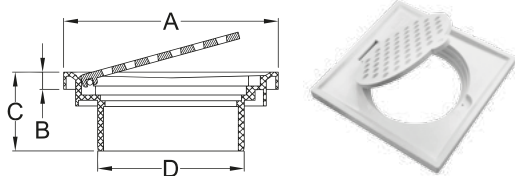

CODE NO.	NOM. SIZE (mm)	DIMENSIONS (mm)			
		A	B	C	D
G150E	150x150	150x150	12	24	102
G15030E	150x150	150x150	12	55	102

SNOW product

SQUARE DOMED GRATING

with Edge, with or without Spigot

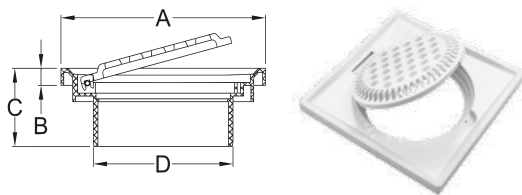

CODE NO.	NOM. SIZE (mm)	DIMENSIONS (mm)			
		A	B	C	D
G150ED	150x150	150x150	12	24	102
G15030ED	150x150	150x150	12	55	102

SNOW product

SQUARE SCREW FLAT GRATING (HEAVY DUTY)

with Edge, with or without Spigot

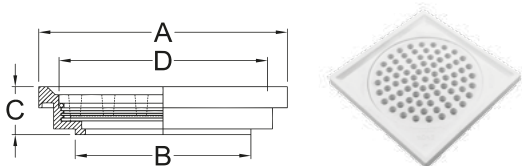

CODE NO.	NOM. SIZE (mm)	DIMENSIONS (mm)			
		A	B	C	D
G150SFE	150x150	150x150	106	29.5	Thread
G15030SFE	150x150	150x150	102	55	Thread

SNOW product

SQUARE SCREW DOMED GRATING (HEAVY DUTY)

with Edge, with or without Spigot

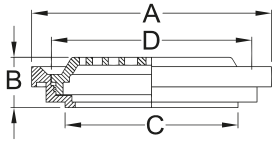

CODE NO.	NOM. SIZE (mm)	DIMENSIONS (mm)			
		A	B	C	D
G150SD	150x150	150x150	22	103	Thread
G15030SD	150x150	150x150	55	102	Thread

SNOW product

(MIS) ANTI-MOSQUITO DEVICE

Place in floor grating

Incorporate valve to allow one way water flow and prevent insect in the pipeline access into your home

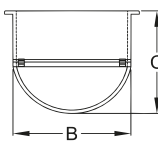
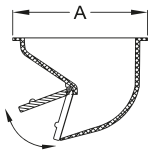

CODE NO.	NOM. SIZE (mm)	DIMENSIONS (mm)		
		A	B	C
AMD98R	98	98	87	42
AMD98S	98	98	87	80

SNOW product

SOLVENT CEMENT



CODE NO.	DESCRIPTION	GMS	TIN / CARTON
60500 12	Paling Coloursolve fast dry (Green)	500	20

SOLVENT CEMENT REQUIREMENT FOR PVC-U PIPES & FITTINGS

NOMINAL SIZE OF PIPE OR FITTING (mm)	AMOUNT OF SOLVENT CEMENT REQUIRED PER JOINT (g)	NO. OF POSSIBLE JOINTS	
		100 g	500 g
15	1.3	76	383
20	2.0	55	250
25	2.5	40	200
32	3.2	30	156
40	5.0	20	100
50	7.2	13	69
80	12.0	8	41
100	15.5	6	32
155	26.0	2	19
200	49.0	1	10
250	75.5	-	6
315	108	-	4

RECOMMENDATIONS ON BRUSH:

- A : Pipes with diameter 25mm and below - use brush as accompanied and affixed to can
- B : Pipes with diameter 32mm to 50mm - use 1" brush
- C : Pipes with diameter 75mm to 200mm - use 2" brush

PHYSICAL AND CHEMICAL PROPERTIES

Flash point: 15°C

Flammable Mixture (UN No. 1133)

This solvent cement material will ignite at ambient temperatures. Colourless vapours may travel considerable distance to ignition sources and cause flash fires or explosions.

Hazard Identification

May cause eyes and skin irritation, burns or dermatitis.

Storage

Store in well-ventilated area. Keep away from heat, sparks and flame.

Safety Advice

- Keep out of reach of children.
- Keep away from sources of ignition - No Smoking.
- Avoid contact with eyes.
- In case of fire, use chemical powder, foam or carbon dioxide.



ABOUT LESSO MALAYSIA INDUSTRIES SDN. BHD.

These systems are suitable for various applications and building types, including domestic, commercial, industrial and civil construction projects. Paling products are accurately designed to consistently exceed the performance aspects specified under widely recognized standards.

Along with ISO 9001 certification and various approvals by SIRIM and IKRAM, Paling products are accredited by NSF, an authority in water industry standards.

Paling products are manufactured under an effective system of inspection, testing, supervision and control.



ABOUT CHINA LESSO GROUP HOLDINGS LIMITED

(Stock Name: China Lesso, Stock Code: 02128.HK)

China Lesso Group Holdings Limited is a large industrial group of home furnishings and building materials in China. China Lesso offers products, services and channels involving piping, building materials and home furnishings, environmental protection, and modern agriculture. With the rapid development of internationalization and globalization, China Lesso boasts more than 80 holding subsidiaries and more than 23 production bases distributed in 17 provinces across China, and in Canada and Indonesia. China Lesso remains committed to improving its strategic layout, broadening its sales network and expanding the market. This is how it provides products and services for customers in a timely and efficient way.

NOTE :

: DATE



PALING

Elegance
RAINGUTTERS

LEAD-FREE PIPE SYSTEMS
SUITABLE FOR BUILDINGS AND HOUSES



PALING

SOIL, WASTE & VENT SYSTEM

LEAD-FREE PIPE SYSTEMS
SUITABLE FOR BUILDINGS, HOUSES AND CIVIL CONSTRUCTION PURPOSES



PALING

UNDERGROUND DRAINAGE & SEWER SYSTEM

LEAD-FREE PIPE SYSTEMS
SUITABLE FOR BUILDINGS, HOUSES AND CIVIL CONSTRUCTION PURPOSES



PALING

RAINWATER SYSTEM & GYROJOINT

LEAD-FREE PIPE SYSTEMS
SUITABLE FOR CIVIL CONSTRUCTION PURPOSES AND BUILDING



PALING

PRESSURE PIPING SYSTEM

LEAD-FREE PIPE SYSTEMS
SUITABLE FOR BUILDINGS, HOUSES AND CIVIL CONSTRUCTION PURPOSES



PALING

HYDROTECH™ MS3 MULTI-LAYER PVC-U

LEAD-FREE PIPE SYSTEMS
SUITABLE FOR BUILDINGS, HOUSES AND CIVIL CONSTRUCTION PURPOSES

Disclaimer

This brochure has been compiled by Lesso Malaysia Industries Sdn Bhd ("the company") to promote better understanding of the technical aspects of the Company's products to assist users in obtaining from them the best possible performance. The brochure is supplied subject to acknowledgment of the following conditions:

- i) The brochure is protected by Copyright and may not be copied or reproduced in any form or by any means in whole or in part without prior consent in writing by the Company.
- ii) Product usage data and advisory information may change from time to time with advances in research and experience. The Company reserves the right to make such changes at any time without notice.
- iii) Correct usage of the Company's products involve engineering judgements which cannot be properly made without full knowledge of all the conditions pertaining to each installation. The Company expressly disclaims all and any liability to any person done by any such person in reliance whether whole or partial upon the whole or any part of the contents of this brochure.
- iv) No offer to trade, nor any conditions of trading, are expressed or implied by the issue or content of this brochure.
- v) Nothing herein shall override the Company's conditions of Sale, which may be obtained from the Registered or any Sales of the Company.
- vi) This brochure is and shall remain the property of the Company, and shall surrendered on demand to the Company.



TRUSTED PIPEWORK FOR LIFE

www.paling.com.my

LESSO MALAYSIA INDUSTRIES SDN. BHD. 202001023994 (1380314-K)

Lot 10072, Persiaran Mahogani Utama 2, Seksyen 4,
Bandar Utama Batang Kali, 44300 Batang Kali,
Selangor Darul Ehsan.

T : +603 6063 6888 (General)
: +603 6057 0580 (Sales)
F : +603 6057 0680
E : sales@paling.com.my



Official Website

Distributed by :

